

# MicroIQ Prox™

## RFID Self Latching

RW  
series

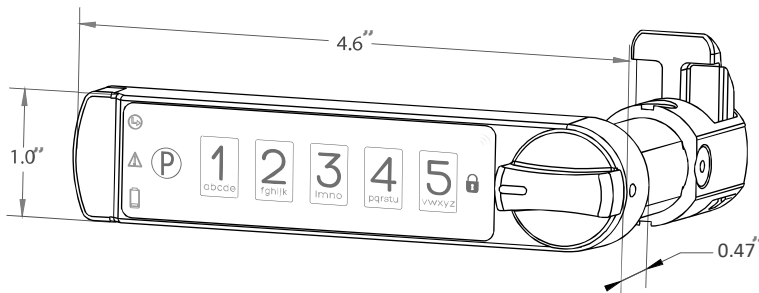

### Installation and Set up

- Wireless installation takes less than 5 minutes
- Easily learn in hundreds of Prox cards and smartphones
- Assign access parameters for each lock, employee, group and location
- Fits into standard double-D key lock holes
- Secured coin cell battery is conveniently accessed from the outside of the lock
- Operates in station mode (repeated use)

### Technology

- Access with your existing RFID cards, fobs, stickers, or smartphone
- Manage access with MicroTraq, ProxTraq, and MobileTraq app/portals
- Enterprise security administration from a single portal
- Generate audit trails to track user activity and lock/unlock attempts
- Remote enrollment of RFID cards and smartphones

### Specifications

<b>Dimensions:</b> 4.6"w x 0.47d x 1.01"h	<b>Power:</b> CR2032 coin cell battery
<b>Network data communication:</b> Bluetooth	<b>Battery life:</b> 1-2 years
<b>Compatible Proxcards:</b> All common standards including 125KHz ( HID Prox and Prox II, HID Indala, AWID, Keri, Ving Card, COTAG, lo Prox, Honeywell, Alarm Lock, ELK, EM, Everfocus, Farpoint, IEl, Kantech, Paradox, Secura Key, Visonic, Best) and 13.56MHz (ISO/IEC 14443A & B, 15693 Standards including, iClass, MIFARE, DESFire, Tagit, ICode)	<b>Operating modes:</b> (1) <u>Station Mode:</u> The lock is accessed by one or more users repeatedly. The lock memory retains codes until these codes are intentionally erased or replaced
<b># of Users:</b> Each lock can store hundreds of users	<b>Keypad:</b> 5 Digit
<b>Levels of access:</b> master (6 digits), supervisor (3-6 digits), and user (3-6 digits)	<b>Operating temperature:</b> 32° - 122°
<b>Locking Mechanism:</b> 4 position adjustable spring bolt, push to close with automatic latching	<b>Storage temperature:</b> 14° to 158°
<b>Shell length:</b> 7/8", 1-3/4", and 2-13/64"	<b>Operating moisture:</b> 20% - 80% Rh
<b>Knob rotation:</b> 90 degrees clockwise or counterclockwise	<b>Interference:</b> Immune to physical shock and magnetic field
<b>Locking position:</b> one or two	<b>Cleaning:</b> withstand bleach and chemical cleaners



[www.microiqlock.com](http://www.microiqlock.com)



[sales@triteqlock.com](mailto:sales@triteqlock.com)



# Mounting details:

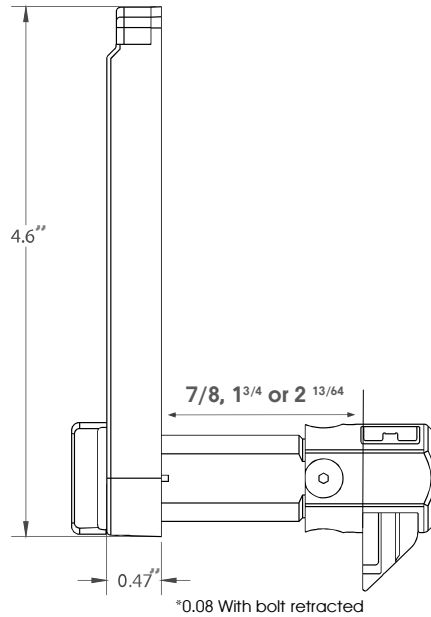

## MOUNTING HOLE DETAILS

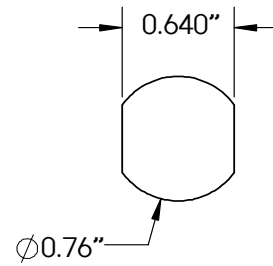

Flats can be parallel or perpendicular to the lock.

## Orientation options:

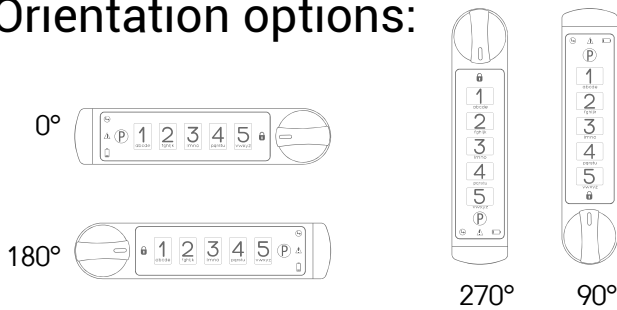

## Knob options:

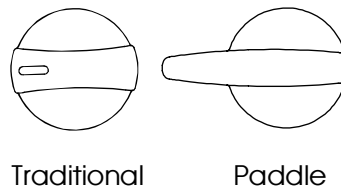

## Power:

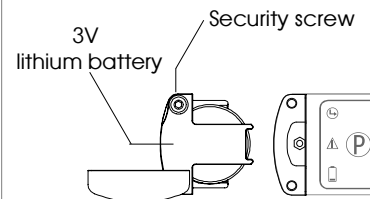

# Lock management via ProxTraq Bluetooth and cloud database:

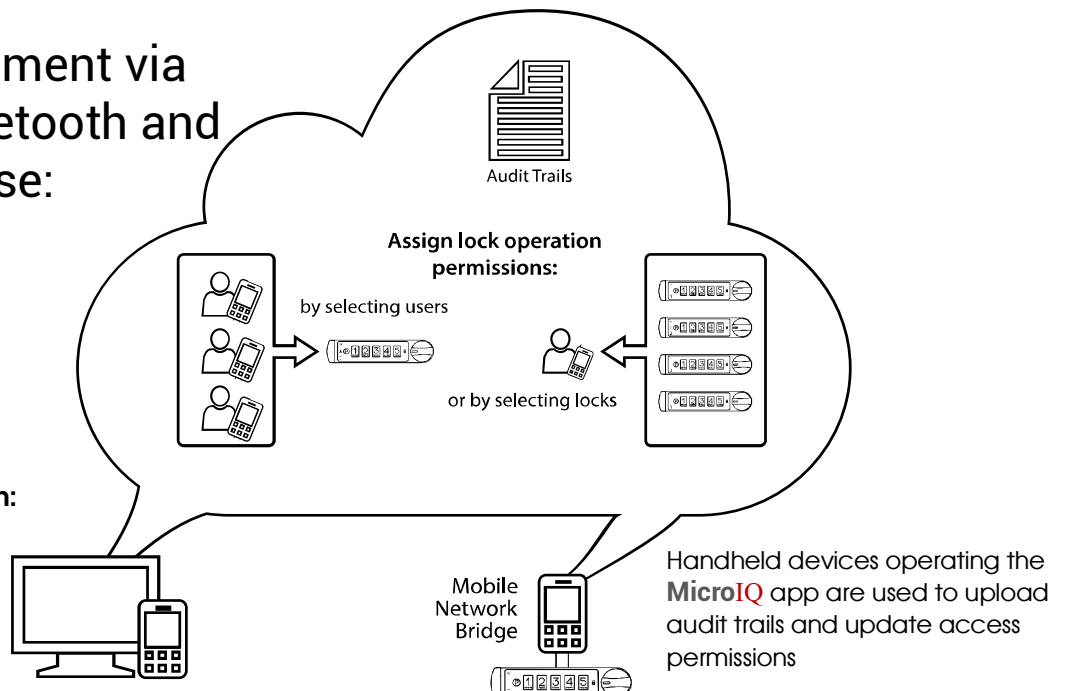

### Remote administration:

- Manage locks
- Manage users
- View audit trails