

MicroIQ Prox™

RFID Cam Replacement

UWL
series

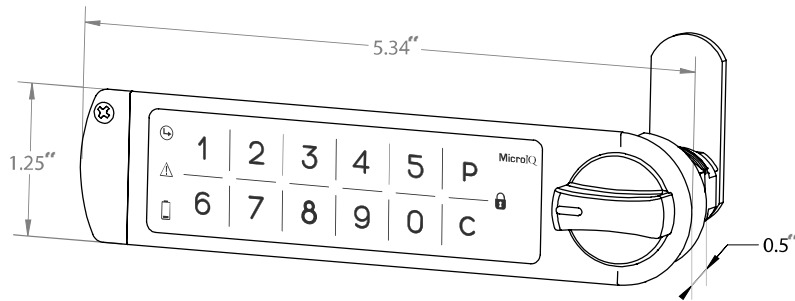

Installation and Set up

- Wireless installation takes less than 5 minutes
- Easily learn in hundreds of Prox cards and smartphones
- Assign access parameters for each lock, employee, group, and location
- Fits into standard double-D key lock holes
- Secured coin cell battery is conveniently accessed from the outside of the lock
- Operates in station mode (repeated use) or locker mode (single use)

Technology

- Access with your existing RFID cards, fobs, stickers, or smartphone
- Manage access with MicroTraq, ProxTraq, and MobileTraq apps/portals
- Enterprise security administration from a single portal
- Generate audit trails to track user activity and lock/unlock attempts
- Remote enrollment of RFID cards and smartphones

Specifications

Dimensions: 5.38" w x 0.5" d x 1.25" h	Power: CR2450 coin cell battery
Network data communication: Bluetooth	Battery life: 1-2 years
Compatible Proxcards: All common standards including 125KHz (HID Prox and Prox II, HID Indala, AWID, Keri, Ving Card, COTAG, lo Prox, Honeywell, Alarm Lock, ELK, EM, Everfocus, Farpoint, IEL, Kantech, Paradox, Secura Key, Visonic, Best) and 13.56MHz (ISO/IEC 14443A & B, 15693 Standards including, iClass, MIFARE, DESFire, Tagit, ICode)	Operating modes: (1) <u>Station Mode:</u> The lock is accessed by one or more users repeatedly. The lock memory retains codes until these codes are intentionally erased or replaced. (2) <u>Locker Mode:</u> For unassigned lockers or other storage units. The user chooses any available locker and enters an RFID card or a one-time self-selected code. This code or card is erased after the user unlocks the lock.
# of Users: Each lock can store hundreds of users	Keypad: 10 Digit
Levels of access: master (6 digits), supervisor (3-6 digits), and user (3-6 digits)	Operating temperature: 32° - 122°
Locking Mechanism: Cam (see reverse side for details)	Storage temperature: 14° to 158°
Shell length: 3/8", 5/8", 7/8", 1 1/8"	Operating moisture: 20% - 80% Rh
Knob rotation: clockwise or counterclockwise; 90 or 180 degrees	Interference: Immune to physical shock and magnetic field
Locking position: one or two	Cleaning: withstand bleach and chemical cleaners



Mounting details:

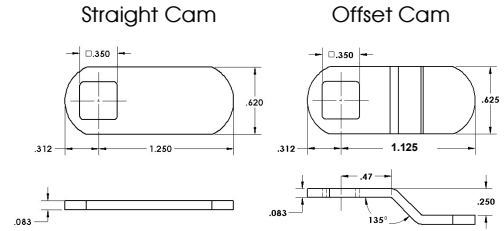
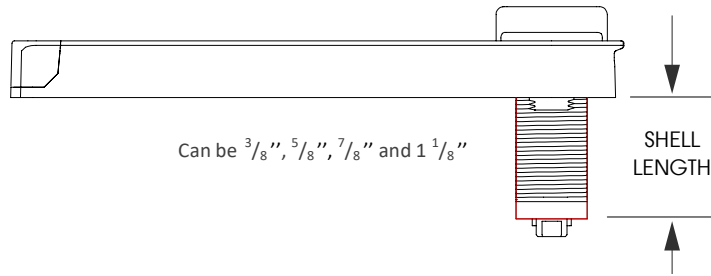
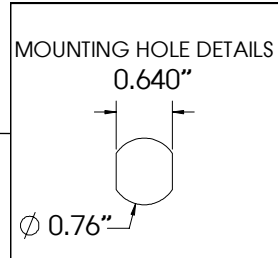
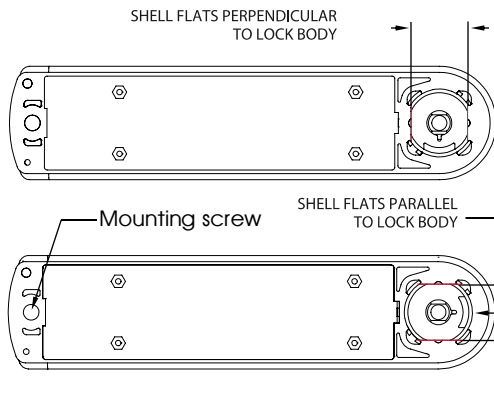

1. Customer can use preferred cam
2. Adapter available for Eurolock applications

Orientation options:

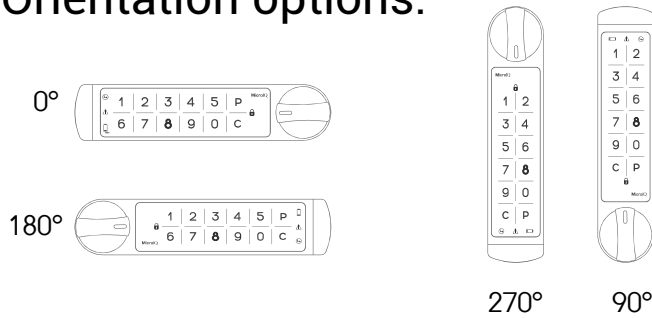

Power:

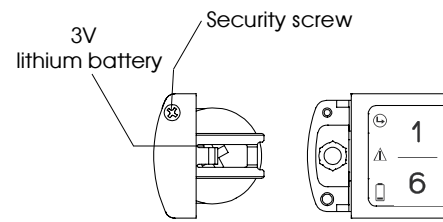

Lock management via ProxTraq, Bluetooth and cloud database:

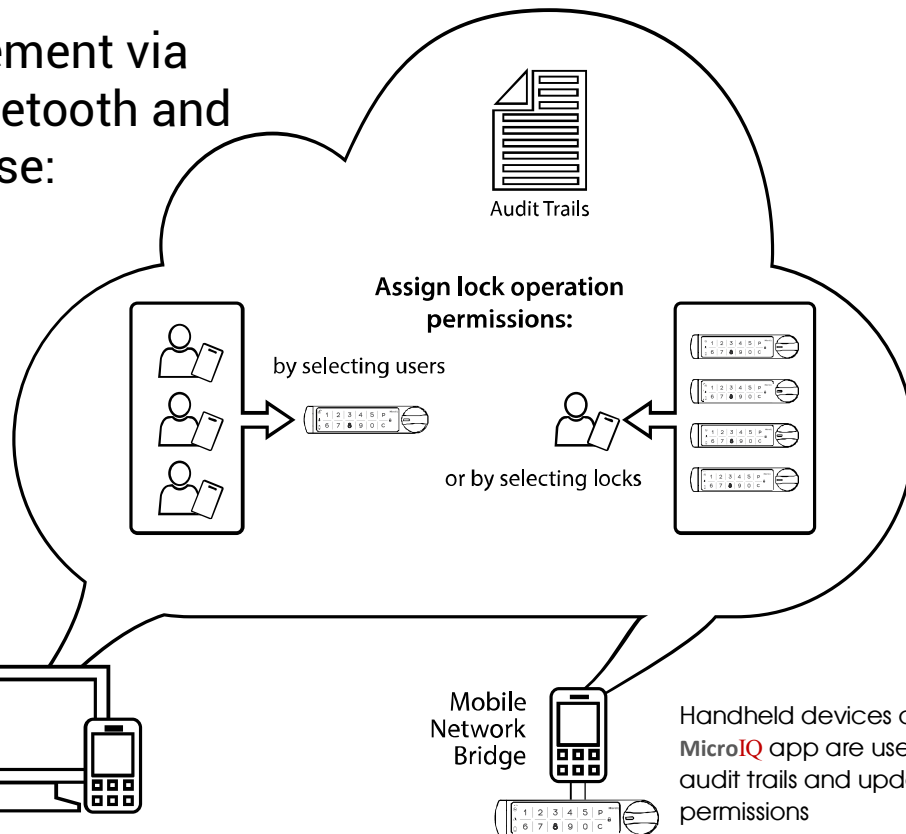

Remote administration:

- Manage locks
- Manage users
- View audit trails